

50 Ω	DC - 4 GHz recommended DC - 10 GHz maximum
75 Ω	DC - 1 GHz recommended DC - 1,5 GHz maximum

GENERAL

- Coaxial connectors standardized worldwide
- 2 bayonet coupling
- Good RF performance
- Proven strength and reliability
- 2 ranges :
 - BNC
 - 75 Ω BNC

APPLICABLE STANDARDS

- MIL-C-39012
- CEI 169-8

APPROVALS

- QPL

APPLICATIONS

- Military & Civil Radio Telecommunication Equipment
- Radio Telephone
- Computer
- Videocommunications
- General Electronics
- Measurement.



INTERFACE

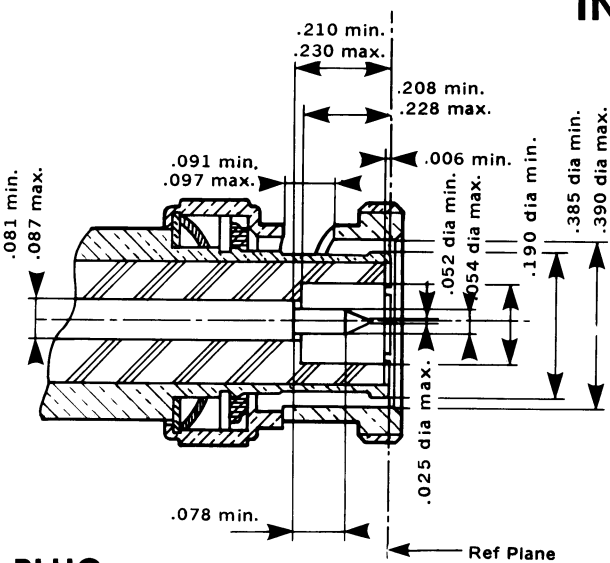

PLUG

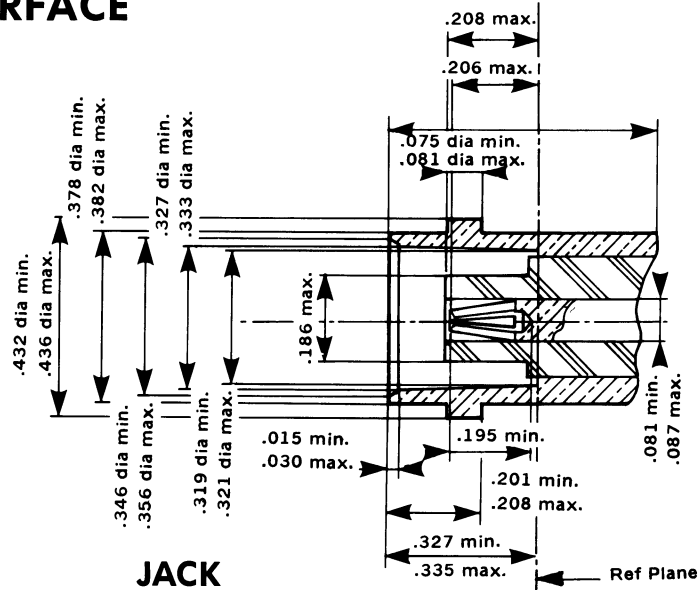

JACK

50 Ω BNC

FLEXIBLE CABLE. CLAMP ATTACHMENT

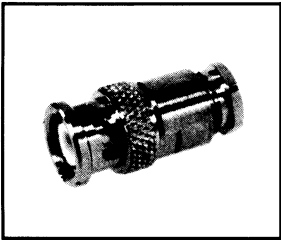

STRAIGHT CABLE PLUG
captured contact

PART No. **R 141 004**

Cable RG 174/U, 179,
187, 188, 316

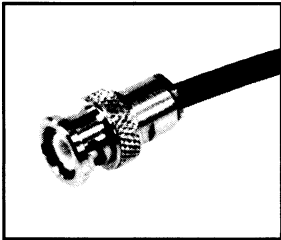

STRAIGHT CABLE PLUG
non-captured contact

PART No. **R 141 007**

UG. No. 88/U

Cable RG 55/U, 58, 141,
142, 223, 303, 400

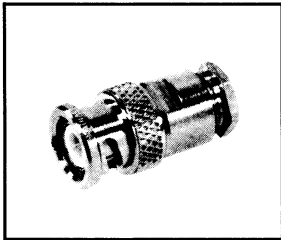

STRAIGHT CABLE PLUG
non-captured contact

PART No. **R 141 008**

UG. No. 88C/U

Cable RG 55/U, 58, 141,
142, 223, 303, 400

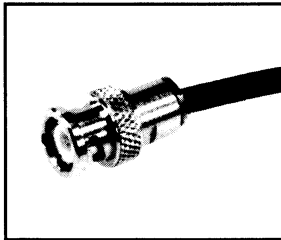

STRAIGHT CABLE PLUG
non-captured contact

PART No. **R 141 011**

UG. No. 260/U

Cable RG 59/U, 62, 71,
140, 210

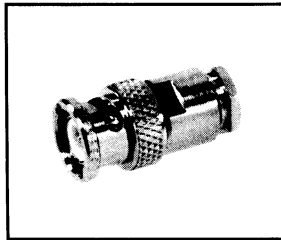

STRAIGHT CABLE PLUG
non-captured contact

PART No. **R 141 012**

UG. No. 260B/U

Cable RG 59/U, 62, 71,
140, 210

FLEXIBLE CABLE. CLAMP ATTACHMENT

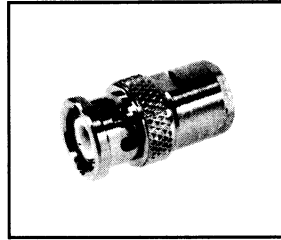

STRAIGHT CABLE PLUG
captured contact

PART No. **R 141 034**

Cable RG 59/U, 62, 71,
140, 210

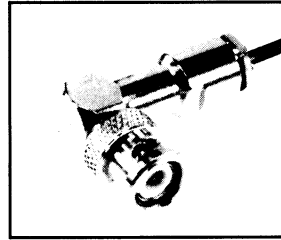

RIGHT ANGLE CABLE PLUG
captured contact

PART No. **R 141 156**

UG. No. 913A/U

Cable RG 55/U, 58, 141,
142, 223, 303, 400

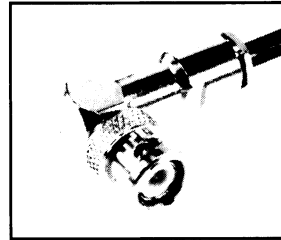

RIGHT ANGLE CABLE PLUG
captured contact

PART No. **R 141 157**

Cable RG 59/U, 62,
71, 140, 210

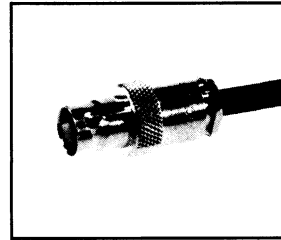

STRAIGHT CABLE JACK
non-captured contact

PART No. **R 141 207**

UG. No. 89C/U

Cable RG 55/U, 58, 141,
142, 223, 303, 400

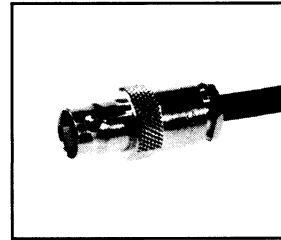

STRAIGHT CABLE JACK
captured contact

PART No. **R 141 210**

UG. No. 261C/U

Cable RG 59/U, 62, 71,
140, 210

FLEXIBLE CABLE. CLAMP ATTACHMENT

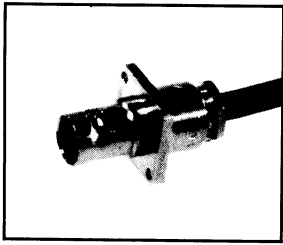

FLANGE MOUNT CABLE JACK
non-captured contact

PART No. **R 141 258**

UG. No. 291C/U

Cable RG 55/U, 58, 141,
142, 223, 303, 400

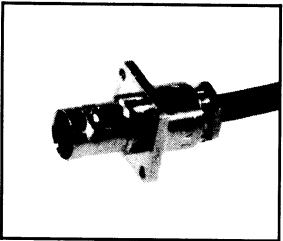

FLANGE MOUNT CABLE JACK
non-captured contact

PART No. **R 141 262**

UG. No. 262C/U

Cable RG 59/U, 62, 71,
140, 210

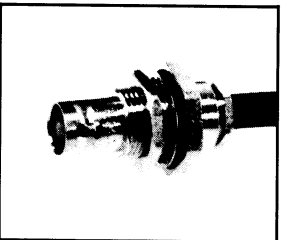

**BULKHEAD FEEDTHROUGH
CABLE JACK**
non-captured contact

PART No. **R 141 327**

UG. No. 909B/U

Cable RG 55/U, 58, 141,
142, 223, 303, 400

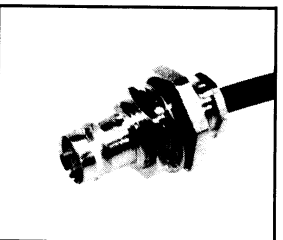

**BULKHEAD FEEDTHROUGH
CABLE JACK**
non-captured contact

PART No. **R 141 329**

Cable RG 59/U, 62, 71,
140, 210

FLEXIBLE CABLE. CRIMP ATTACHMENT

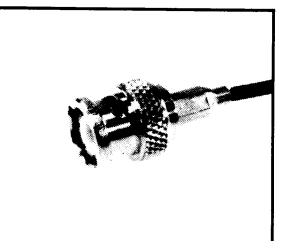

STRAIGHT CABLE PLUG
captured contact

PART No. **R 141 075**

Cable RG 174/U, 179,
187, 188, 316

FLEXIBLE CABLE. CRIMP ATTACHMENT

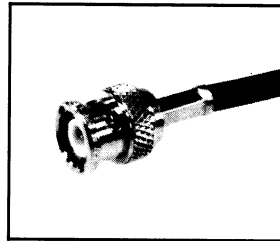

STRAIGHT CABLE PLUG
captured contact

PART No. **R 141 082**

UG. No. 1785/U

Cable RG 58/U, 141, 303

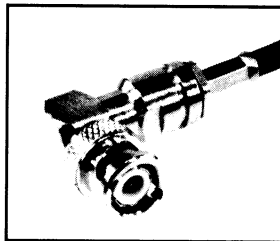

RIGHT ANGLE CABLE PLUG
captured contact

PART No. **R 141 182**

Cable RG 58/U, 141, 303

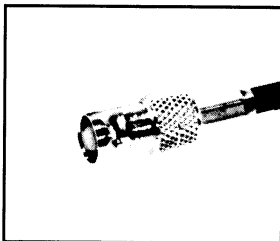

STRAIGHT CABLE JACK
captured contact

PART No. **R 141 237**

UG. No. 1794/U

Cable RG 58/U, 141, 303

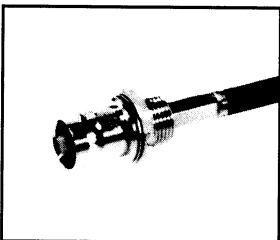

**BULKHEAD FEEDTHROUGH
CABLE JACK**
captured contact

PART No. **R 141 308**

Cable RG 58/U, 141, 303

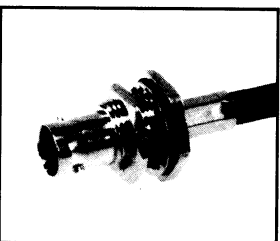

**BULKHEAD FEEDTHROUGH
CABLE JACK**
captured contact

PART No. **R 141 334 500**

Cable RG 59/U, 62,
71, 140, 210

FLEXIBLE CABLE. CRIMP ATTACHMENT

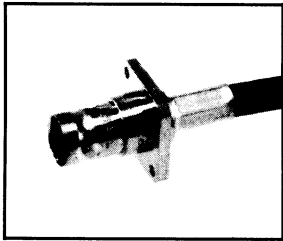

FLANGE MOUNT CABLE JACK
captured contact

PART No. **R 141 292**

Cable RG 58/U, 141,303

PANEL MOUNT. SOLDER POT TERMINAL

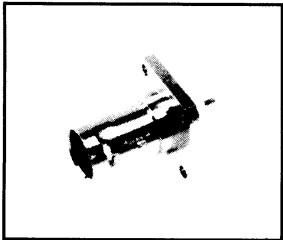

FLANGE MOUNT JACK RECEPTACLE

PART No. **R 141 404**

UG. No. 290A/U

BULKHEAD MOUNT. SOLDER POT TERMINAL

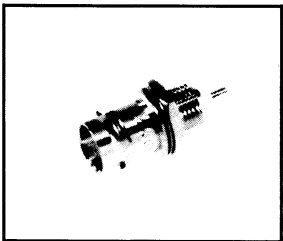

BULKHEAD FEEDTHROUGH JACK RECEPTACLE

PART No. **R 141 554**

UG. No. 625B/U

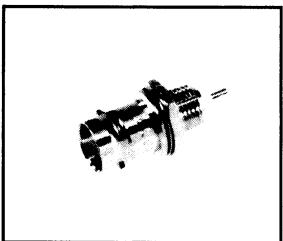

BULKHEAD FEEDTHROUGH JACK RECEPTACLE

PART No. **R 141 557**

UG. No. 1094/U

Center contact gold plated

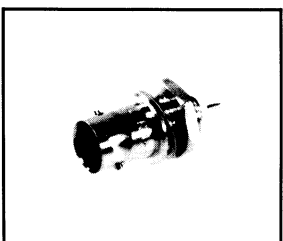

BULKHEAD FEEDTHROUGH JACK RECEPTACLE

PART No. **R 141 563 161**

UG. No. 1094/U

Center contact silver plated

BULKHEAD MOUNT. SOLDER POT TERMINAL

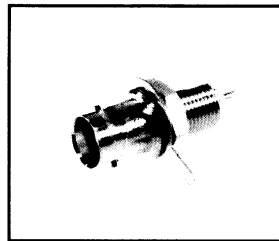

BULKHEAD FEEDTHROUGH JACK RECEPTACLE
Solder plug

PART No. **R 141 559**

UG. No. 1094B/U

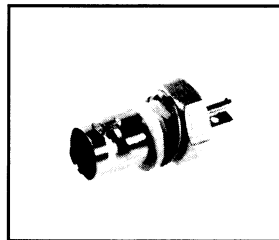

BULKHEAD FEEDTHROUGH JACK RECEPTACLE
Isolated ground

PART No. **R 141 574**

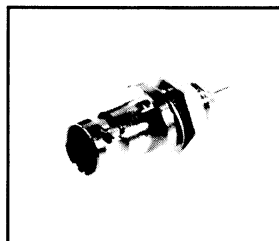

BULKHEAD FEEDTHROUGH JACK RECEPTACLE
Panel seal

PART No. **R 141 603**

UG. No. 657/U

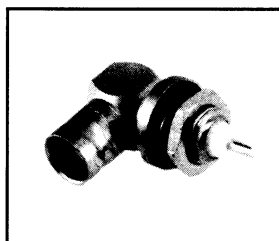

RIGHT ANGLE BULKHEAD FEEDTHROUGH JACK RECEPTACLE

PART No. **R 141 680**

UG. No. 1098/U

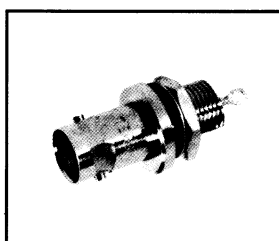

BULKHEAD FEEDTHROUGH JACK RECEPTACLE TAB TERMINAL
Hermetic seal

PART No. **R 141 625**

UG. No. 912/U

PRINTED CIRCUIT BOARD

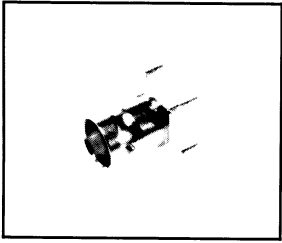

STRAIGHT JACK RECEPTACLE

PART No. **R 141 426**

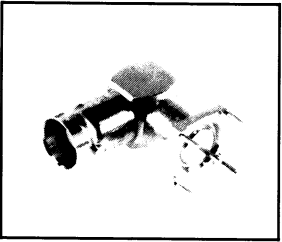

RIGHT ANGLE JACK RECEPTACLE

PART No. **R 141 665**

IN - SERIES ADAPTERS

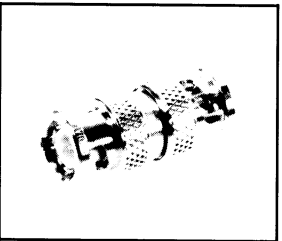

PLUG TO PLUG ADAPTER

PART No. **R 141 703**

UG. No. 491B/U

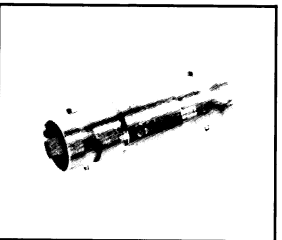

JACK TO JACK ADAPTER

PART No. **R 141 704**

UG. No. 914/U

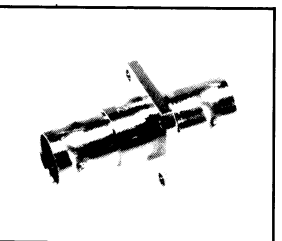

**JACK TO JACK ADAPTER
FLANGE MOUNT**

PART No. **R 141 710**

UG. No. 414A/U

IN - SERIES ADAPTERS

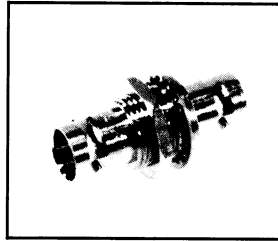

**JACK TO JACK ADAPTER
BULKHEAD FEEDTHROUGH**

PART No. **R 141 720**

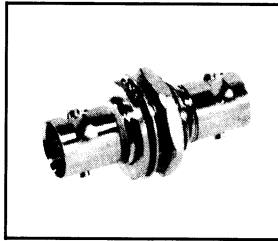

**JACK TO JACK ADAPTER
BULKHEAD FEEDTHROUGH
Isolated Ground**

PART No. **R 141 722**

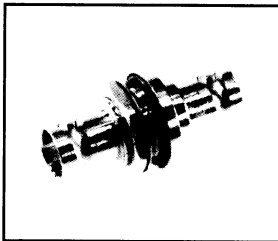

**JACK TO JACK ADAPTER
BULKHEAD FEEDTHROUGH
Hermetic seal with gasket**

PART No. **R 141 753**

UG. No. 492B/U

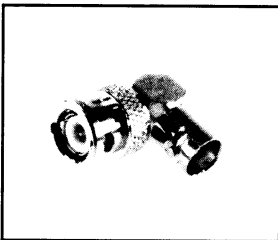

**PLUG TO JACK ADAPTER
RIGHT ANGLE**

PART No. **R 141 770**

UG. No. 306B/U

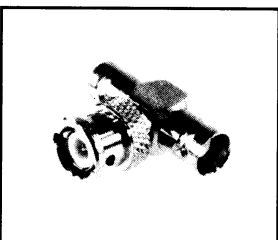

**TEE-JACK TO PLUG TO
JACK ADAPTER**

PART No. **R 141 780**

UG. No. 274B/U

FLEXIBLE CABLE. CLAMP ATTACHMENT

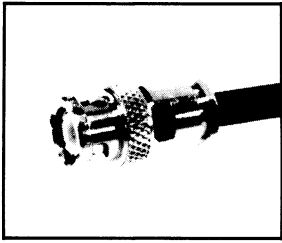

STRAIGHT CABLE PLUG
captured contact

PART No. **R 142 016**

UG. No. 260F/U

Cable RG 59/U, 62, 71,
140, 210

FLEXIBLE CABLE. CRIMP ATTACHMENT

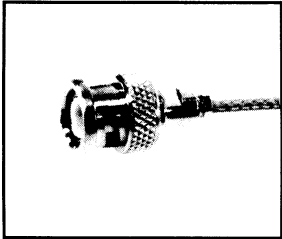

STRAIGHT CABLE PLUG
captured contact

PART No. **R 142 076**

Cable RG 179/U, 187

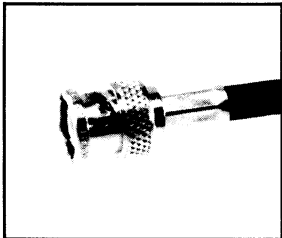

STRAIGHT CABLE PLUG
captured contact

PART No. **R 142 085**

UG. No. 1789/U

Cable RG 59/U, 62, 71,
140, 210

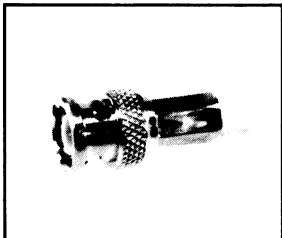

STRAIGHT CABLE PLUG
captured contact

PART No. **R 142 090**

Cable Belden 8281,
BICC 3205

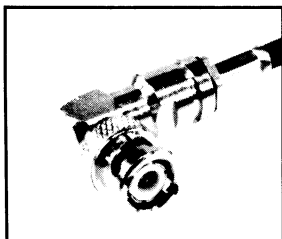

RIGHT ANGLE CABLE PLUG
captured contact

PART No. **R 142 184**

Cable RG 59/U, 62, 71,
140, 210

FLEXIBLE CABLE. CRIMP ATTACHMENT

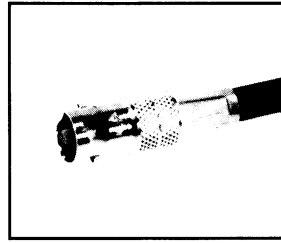

STRAIGHT CABLE JACK
captured contact

PART No. **R 142 242**

Cable RG 59/U, 62, 71,
140, 210

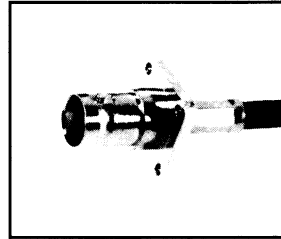

FLANGE MOUNT CABLE JACK
captured contact

PART No. **R 142 295**

Cable RG 59/U, 62, 71,
140, 210

BULKHEAD MOUNT. SOLDER POT TERMINAL

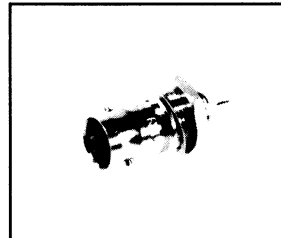

BULKHEAD FEEDTHROUGH
JACK RECEPTACLE

PART No. **R 142 562**